

## SISTEMI A SCOMPARSA PER CHIUSURE SCORREVOLI

NEW SPACE - SPACE  
INTERNI ED ESTERNI

## *HIDE-AWAY SLIDING CLOSURE SYSTEMS*

*NEW SPACE - SPACE  
OUTDOOR AND INDOOR*

NEW SPACE pag. 11  
*NEW SPACE page 11*



NEW SPACE E I SUOI ACCESSORI pag. 21  
*NEW SPACE AND ITS ACCESSORIES page 21*

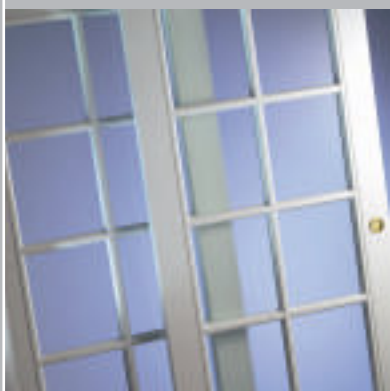

SPACE PRIMATO pag. 27  
*SPACE PRIMATO page 27*

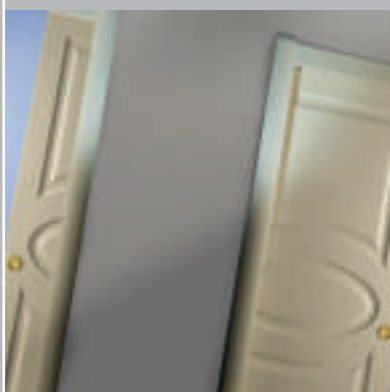

SPACE DUETTO pag. 33  
*SPACE DUETTO page 33*

SISTEMI A SCOMPARSA  
PER CHIUSURE SCORREVOLI  
PER ESTERNI pag. 39  
*HIDE-AWAY SLIDING CLOSURE  
SYSTEMS FOR OUTDOOR page 39*

SISTEMA NEW SPACE - SPACE.  
LA CONQUISTA DI NUOVI SPAZI.

Voi, la vostra casa, il vostro mondo. La porta scorrevole è uno degli elementi distintivi tra un ambiente e l'altro oltre che un'espressione chiara della vostra personalità. Con l'alta tecnologia costruttiva unita alle molteplici possibilità di personalizzazione, i cassonetti Dierre della linea Space conferiranno alla casa uno stile tutto vostro senza farvi rinunciare alla chiusura che volete. Se poi considerate i notevoli vantaggi in fatto d'ingombro che una porta scorrevole dà rispetto a quelle tradizionali, scoprirete che Space è il cassonetto ideale per qualsiasi situazione.

*NEW SPACE – SPACE SYSTEM.  
CONQUERING NEW SPACES.*

*You, your home, your world. The sliding door is one of the distinctive elements between one environment and the other in addition to being the clear expression of your personality. Top manufacturing technology together with customisation options will allow the Dierre Space hide-away closure systems to give your home a personal style without making you give up the closure system that you require. If the remarkable advantages regarding the space taken up that a sliding door gives in comparison to traditional ones are taken into consideration, you'll discover that Space is the hide-away closure system ideal for any location.*





New Space Unico + porta interna Baldi 10 rovere sbiancato - vetro tipo angoli quadri

*New Space Unico, Baldi 10 internal door in bleached oak - Angoli Quadri type glass*

## DIERRE HA CONQUISTATO LO SPAZIO. DIERRE'S SPACE CONQUEST.

Dal 1990 DIERRE produce sistemi a scomparsa per chiusure scorrevoli interne. Una lunga esperienza che ha portato l'azienda a confermare la notorietà acquisita non solo per le chiusure di sicurezza, ma anche per i sistemi a scomparsa. Per rispondere alle nuove esigenze del mercato, nel 1994, l'azienda inizia a produrre anche sistemi a scomparsa per chiusure scorrevoli esterne. Un continuo miglioramento, qualitativo e tecnologico, che porta all'apertura del nuovo stabilimento di 10.000 mq, con una linea di produzione all'avanguardia e, dal gennaio 2006, alla realizzazione di NEW SPACE DIERRE, il nuovo cassonetto dalle caratteristiche innovative. Oggi DIERRE produce ogni anno 130.000 sistemi a scomparsa per chiusure scorrevoli: ognuno realizzato con la massima cura, rispettando tutte le normative ISO di qualità, e pronto per rivoluzionare il modo di vivere la casa.

*Since 1990 Dierre has been producing indoor hide-away sliding closure systems. A long experience that has led the company to confirm the recognition acquired not only for security doors but also for hide-away systems. In 1994 to respond to the new market requirements, the company also begun to produce outdoor hide-away sliding closure systems. A continuous improvement, from the quality and technological point of view, leading to the opening of the new 10,000 m2 plant with a vanguard production line and, from January 2006, the implementation of NEW SPACE DIERRE, the new innovative structure. Nowadays Dierre produces each year 130,000 hide-away sliding closure systems: each made with the utmost care, complying with all the ISO quality standards, and ready to revolutionize the way of living your home.*



L' identità e la solidità di un marchio aziendale  
per il sistema di chiusura a scomparsa.

*The identity and reliability of a corporate trade  
mark for the hide-away closure system.*

DIERRE ha ottenuto la certificazione ISO 9001: un'attestazione concreta della capacità di operare secondo i più severi criteri di qualità totale, in linea con i rigorosi standard internazionali. Le tecnologie più avanzate nella lavorazione dell'acciaio, un' intensa attività di ricerca e controllo, un'organizzazione efficiente ed un servizio attivo in Italia ed in Europa: ecco le risorse che DIERRE riunisce sotto un unico marchio, per offrire al cliente il massimo livello qualitativo, insieme alla più attenta personalizzazione del prodotto.

*Dierre has obtained the ISO 9001 certification: a tangible acknowledgement of the capability to operate according to the strictest total quality criteria, in line with the stringent international standards. The most advanced technologies in steel manufacturing, an intense research and control activity, an efficient organisation and a service active both in Italy and in Europe: here are the resources that Dierre gathers under a single brand, to offer their customers the utmost quality level, together with the more attentive product customisation.*









SISTEMA A SCOMPARSA  
PER CHIUSURE SCORREVOLI PER ESTERNI

*HIDE-AWAY SLIDING CLOSURE SYSTEMS FOR OUTDOOR*

SPACE MONO - DUO - TRIO





Space Mono per Greta porta finestra scorrevole a due ante, trama tipo W, serratura a cilindro, laccata bianca.

*Space Mono for Greta double leaf sliding French door, W type pattern, cylinder lock, lacquered white.*

DIERRE SPACE PER ESTERNI.  
*DIERRE SPACE FOR OUTDOOR.*



Le varianti Mono, Duo e Trio del sistema Dierre Space per esterni sono una vera e propria rivoluzione dello spazio. Ogni modello è studiato per garantire alti standard di sicurezza e rispettare lo stile della vostra abitazione. Offrendovi la massima praticità d'impiego e un ingombro minimo.

#### DIERRE SPACE MONO

Può ospitare, in alternativa alla grata di sicurezza, la persiana in legno o la finestra; Dierre Space MONO MOTORIZZATO per le persiane in legno.

#### DIERRE SPACE DUO

Per grate di sicurezza con persiana in legno, grata di sicurezza più finestra o persiana in legno con finestra.

#### DIERRE SPACE TRIO

Per grata di sicurezza più persiana in legno più finestra.

*The Mono, Duo and Trio variants of the Dierre Space system for outdoor are a real revolution in space. Each model is designed to ensure high security standards and to match the style of your house. Offering you the maximum ease of use and a minimum space taken up.*

#### DIERRE SPACE MONO

*Alternatively to the security grille, it can accommodate, the wooden shutter or the window; Dierre Space MONO MOTOR DRIVEN for wooden shutters.*

#### DIERRE SPACE DUO

*For security grille with wooden shutter, security grille and window or wooden shutter and window.*

#### DIERRE SPACE TRIO

*For security grille with wooden shutter and window.*



SPACE MONO SINGOLO PER GRATA O PERSIANA IN LEGNO SCORREVOLE  
 SPACE MONO SINGLE FOR GRILLE OR SLIDING WOODEN SHUTTER

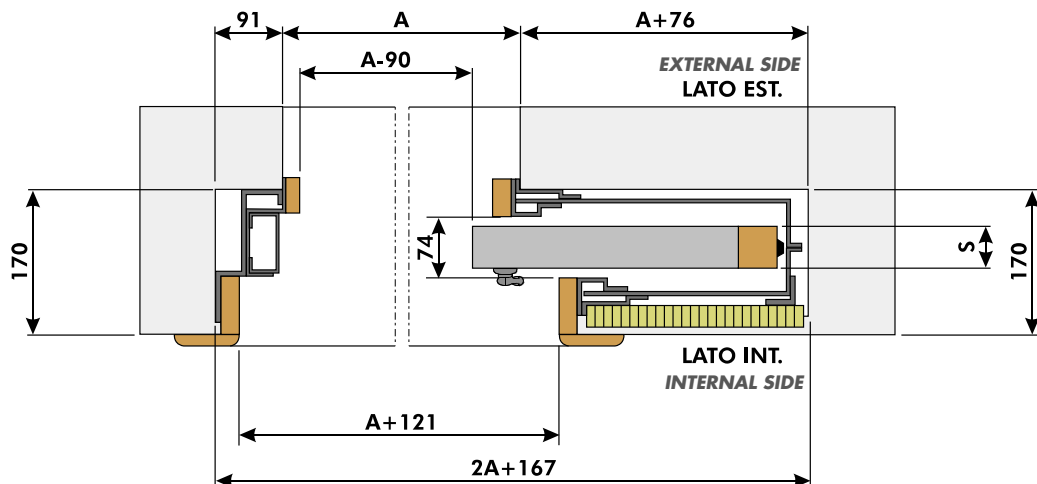
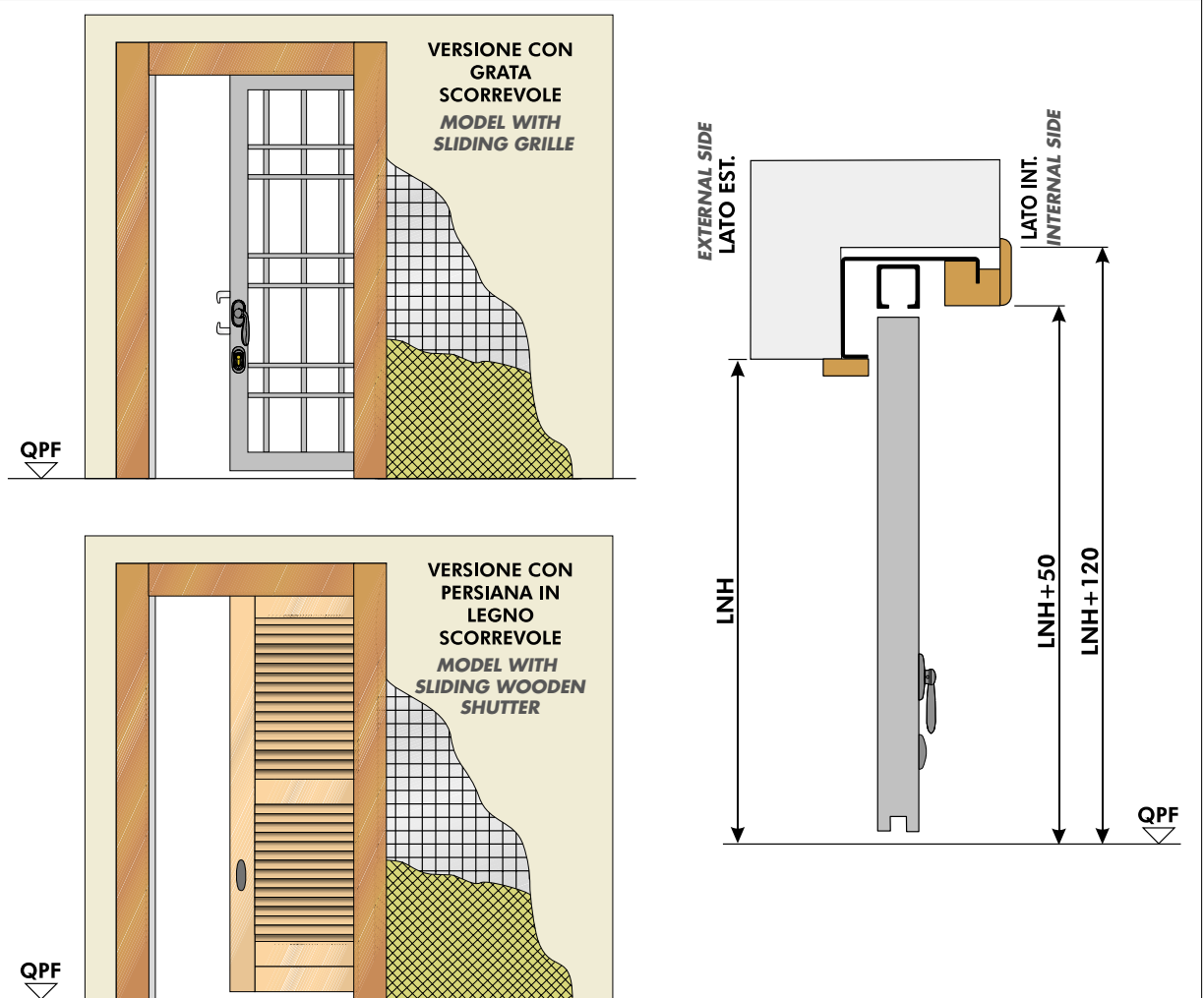

MISURE <b><i>DIMENSIONS</i></b>			
A	LNH	GRATA <i>GRILLE</i>	PERSIANA <i>SHUTTER</i>
Da/From 390 a/to 2590	Da/From 800 a/to 2900	S= 45 H= LNH+12 L= A+32	S= 40/60 H= LNH+12 L= A+32

LE MISURE SONO ESPRESSE  
 IN MILLIMETRI

A=LARGHEZZA VANO MURO  
 LNH= ALTEZZA VANO MURO

***DIMENSIONS ARE EXPRESSED IN MM***

A = WALL OPENING WIDTH  
 LNH = WALL OPENING HEIGHT



SPACE MONO DOPPIO PER GRATA O PERSIANA IN LEGNO SCORREVOLE  
 SPACE MONO DOUBLE FOR GRILLE OR SLIDING WOODEN SHUTTER.

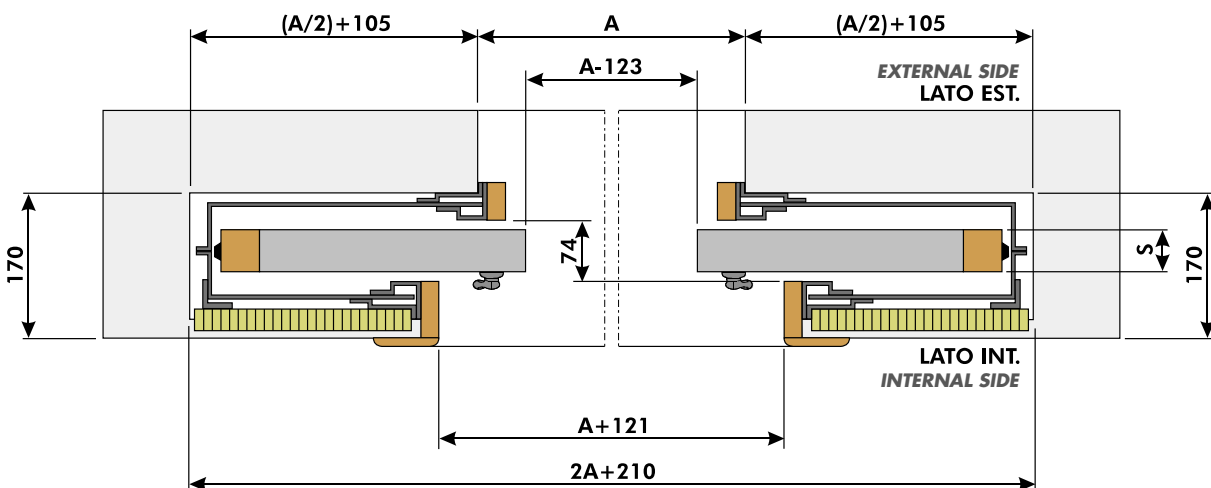
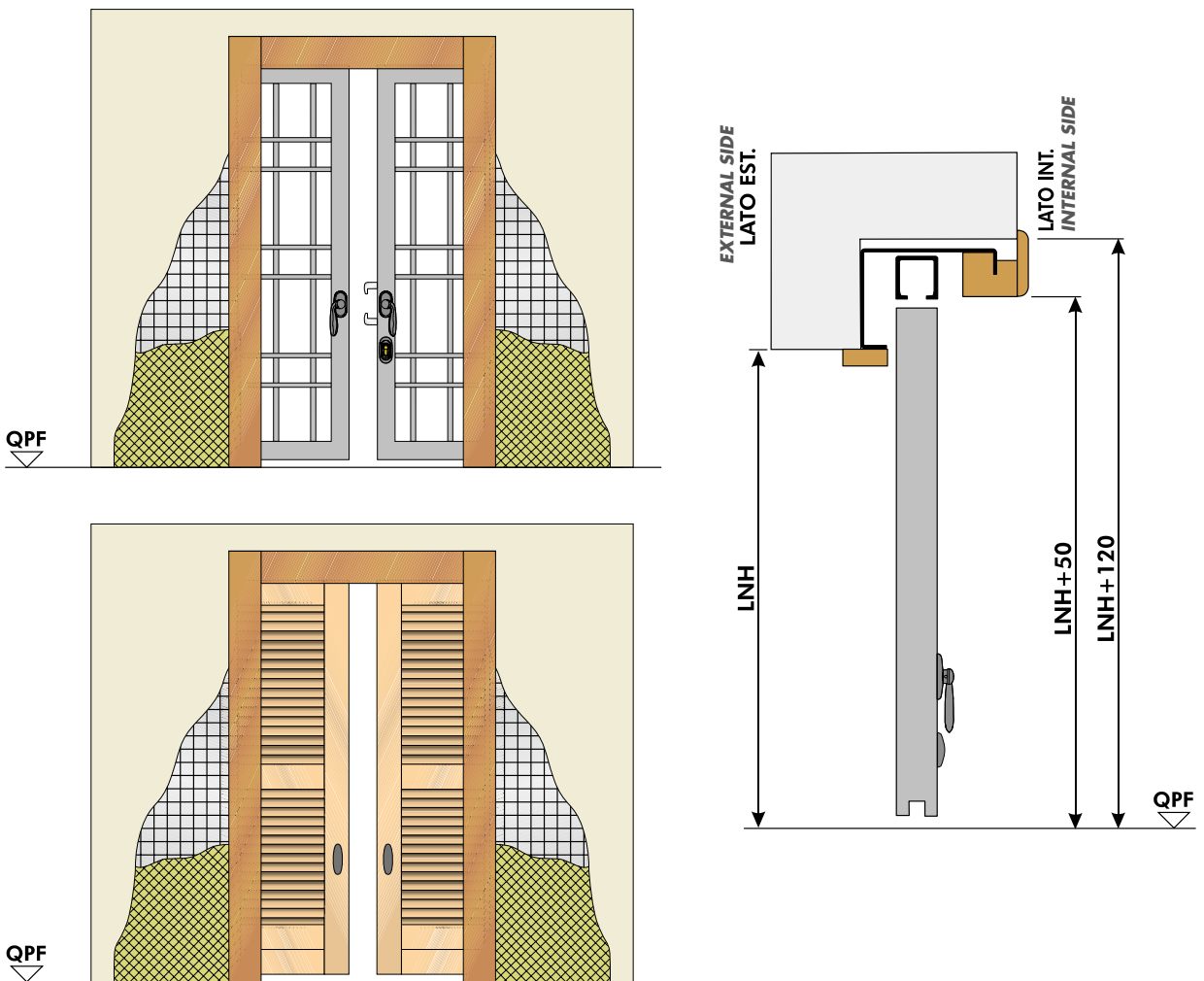

<b>MISURE DIMENSIONS</b>			
<b>A</b>	<b>LN H</b>	<b>GRATA GRILLE</b>	<b>PERSIANA SHUTTER</b>
Da/From 725 a/to 5125	Da/From 800 a/to 2900	S= 45 H= LN H+12 L= (A/2)+27	S= 40/60 H= LN H+12 L= (A/2)+27

LE MISURE SONO ESPRESSE  
 IN MILLIMETRI

A=LARGHEZZA VANO MURO  
 LN H= ALTEZZA VANO MURO

DIMENSIONS ARE EXPRESSED IN MM

A = WALL OPENING WIDTH  
 LN H = WALL OPENING HEIGHT

SPACE MONO SINGOLO PER FINESTRA O PORTAFINESTRA AD ALZANTE SCORREVOLE  
 SPACE MONO SINGLE FOR WINDOWS OR LIFT SLIDING FRENCH DOOR

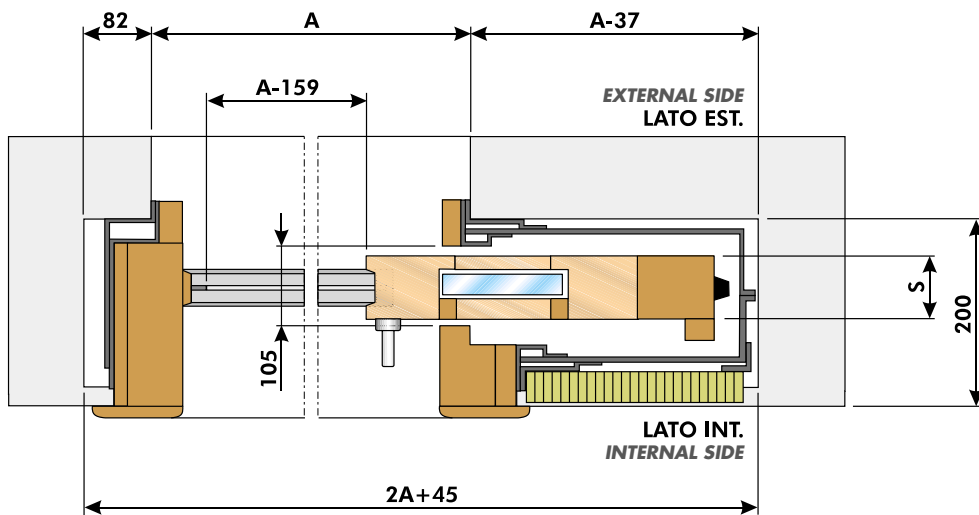
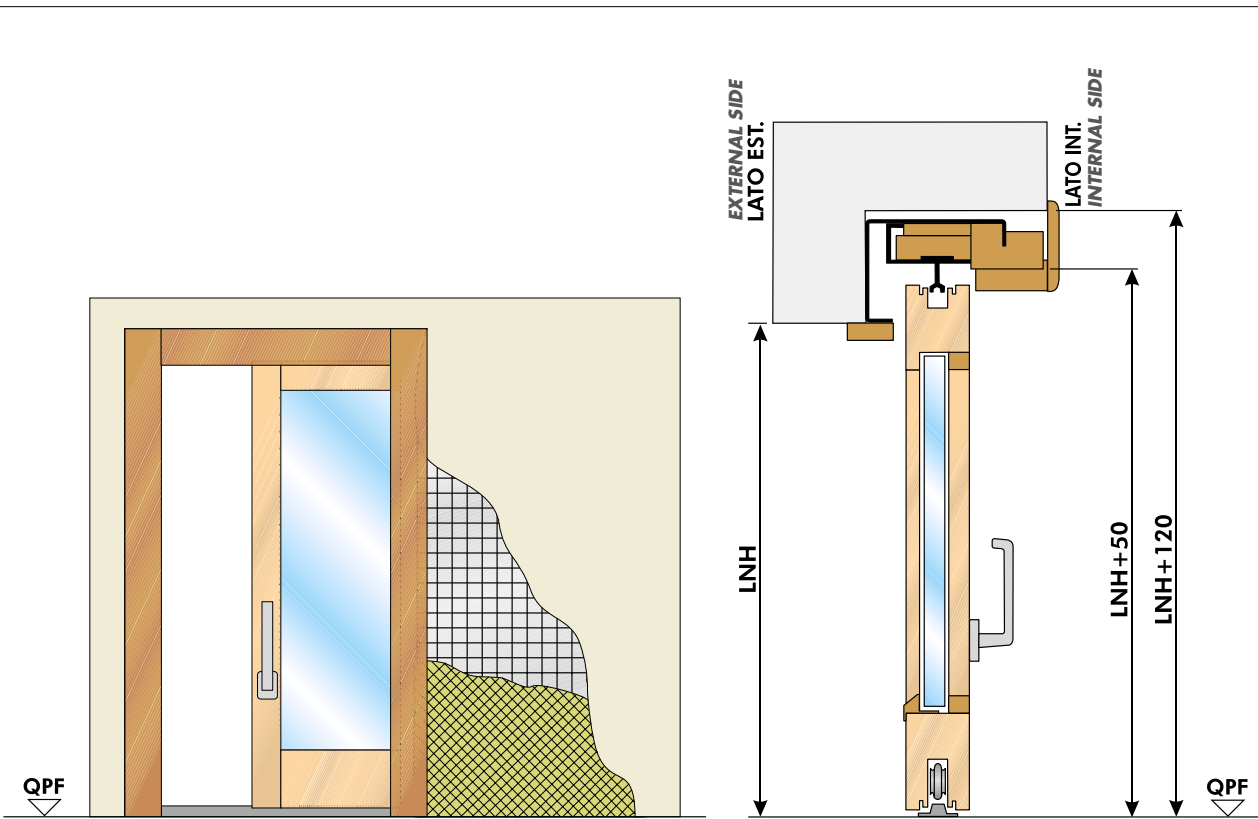

MISURE <b><i>DIMENSIONS</i></b>		
A	LNH	ALZANTE <i>LIFT SIDE</i>
D $\alpha$ /From 760 a/to 2660	D $\alpha$ /From 800 a/to 2900	S= 56/68 H= LNH+18 L= A-71

LE MISURE SONO ESPRESSE  
 IN MILLIMETRI

A=LARGHEZZA VANO MURO  
 LNH= ALTEZZA VANO MURO

***DIMENSIONS ARE EXPRESSED IN MM***

A = WALL OPENING WIDTH  
 LNH = WALL OPENING HEIGHT

SPACE MONO DOPPIO PER FINESTRA O PORTAFINESTRA AD ALZANTE SCORREVOLE  
 SPACE MONO DOUBLE FOR WINDOWS OR LIFT SLIDING FRENCH DOOR

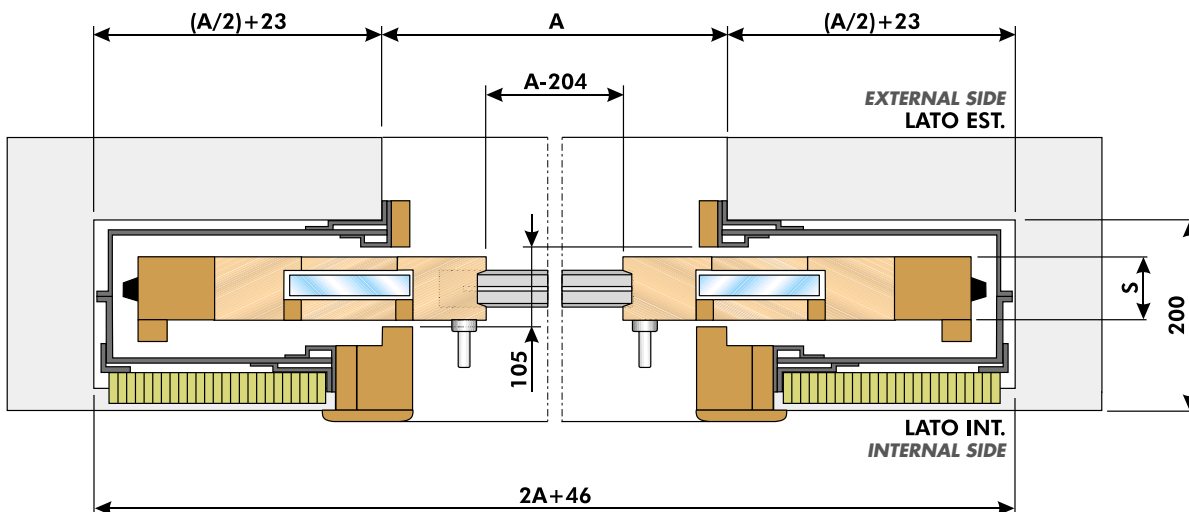
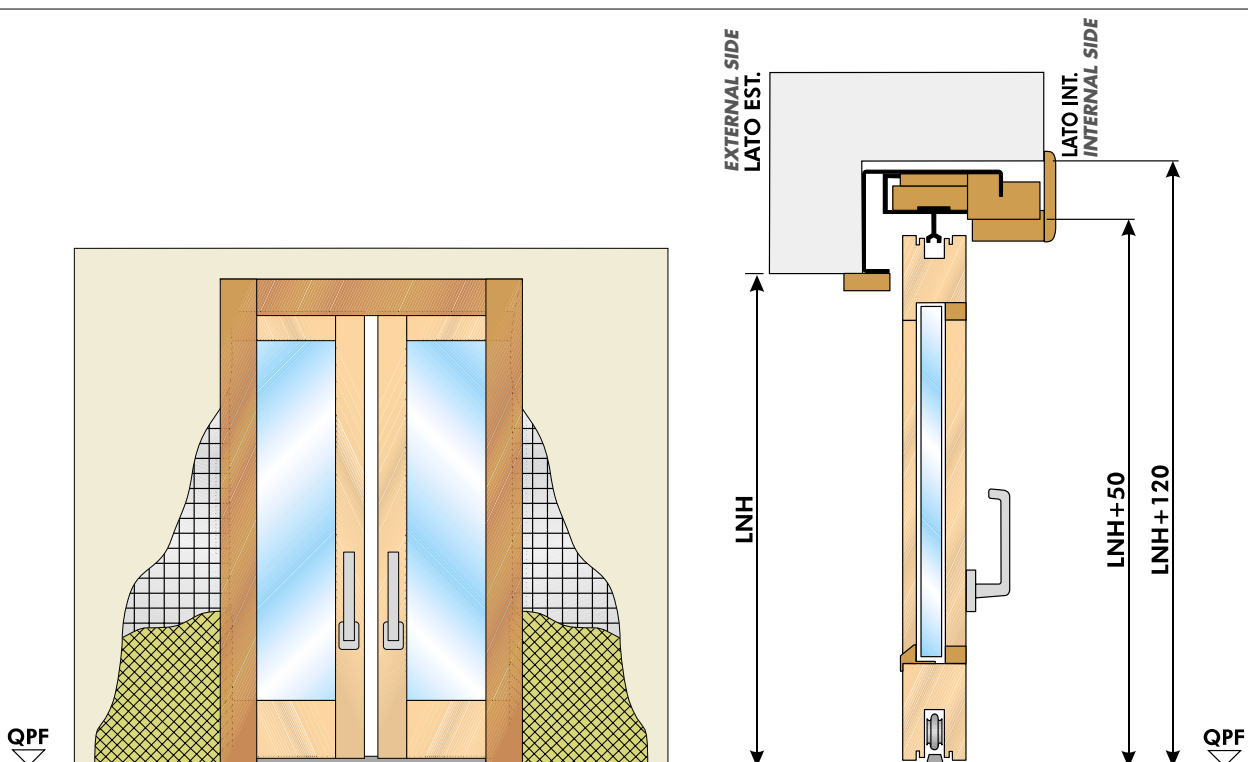

MISURE <b><i>DIMENSIONS</i></b>		
A	LNH	ALZANTE LIFT SIDE
Da/From 1405 a/to 5205	Da/From 800 a/to 2900	S= 56/68 H= LNH+18 L= (A/2)-14

LE MISURE SONO ESPRESSE  
 IN MILLIMETRI

A=LARGHEZZA VANO MURO  
 LNH= ALTEZZA VANO MURO

***DIMENSIONS ARE EXPRESSED IN MM***

A = WALL OPENING WIDTH  
 LNH = WALL OPENING HEIGHT





Space Duo per finestra scorrevole e grata scorrevole

*Space Duo for sliding window and sliding grille*

# SPACE DUO SINGOLO PER GRATA PIU' PERSIANA IN LEGNO SCORREVOLE

## SPACE DUO SINGLE FOR GRILLE AND SLIDING WOODEN SHUTTER

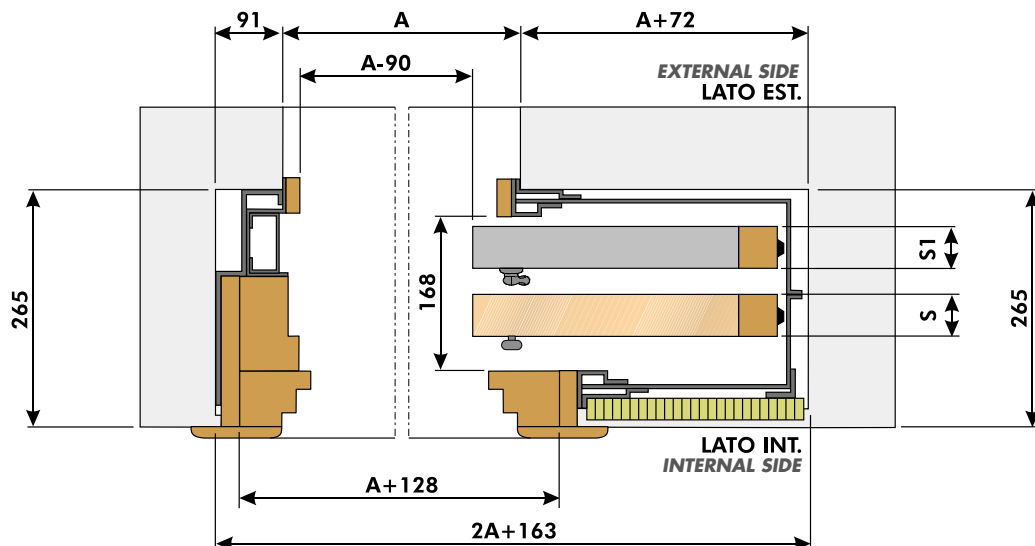
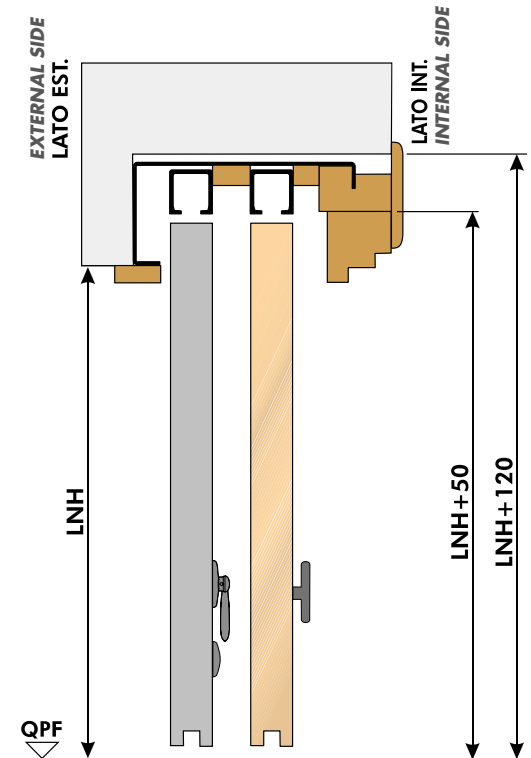
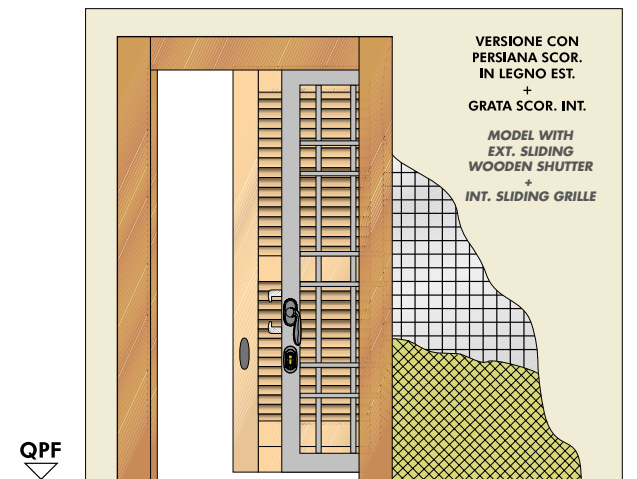
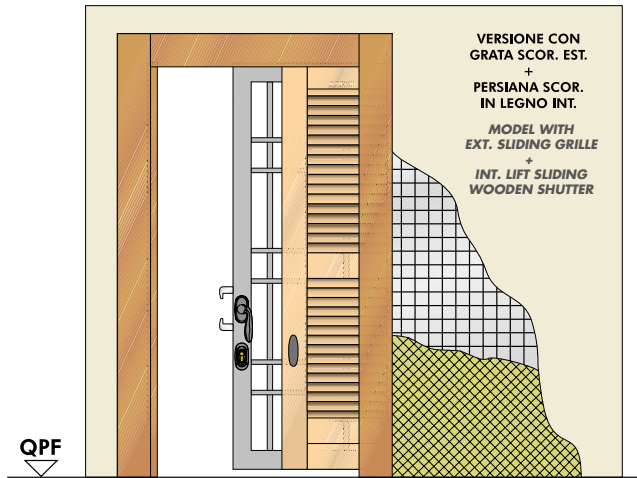

MISURE <i>DIMENSIONS</i>			
A	LNH	GRATA GRILLE	PERSIANA SHUTTER
Da/From 390 a/to 2590	Da/From 800 a/to 2900	S1= 45 H= LNH+12 L= A+32	S= 40/60 H= LNH+12 L= A+32

LE MISURE SONO ESPRESSE IN MILLIMETRI

A=LARGHEZZA VANO MURO  
 LNH= ALTEZZA VANO MURO

*DIMENSIONS ARE EXPRESSED IN MM*

A = WALL OPENING WIDTH  
 LNH = WALL OPENING HEIGHT

SPACE DUO DOPPIO PER GRATA PIU' PERSIANA IN LEGNO SCORREVOLE  
 SPACE DUO DOUBLE FOR GRILLE AND SLIDING WOODEN SHUTTER

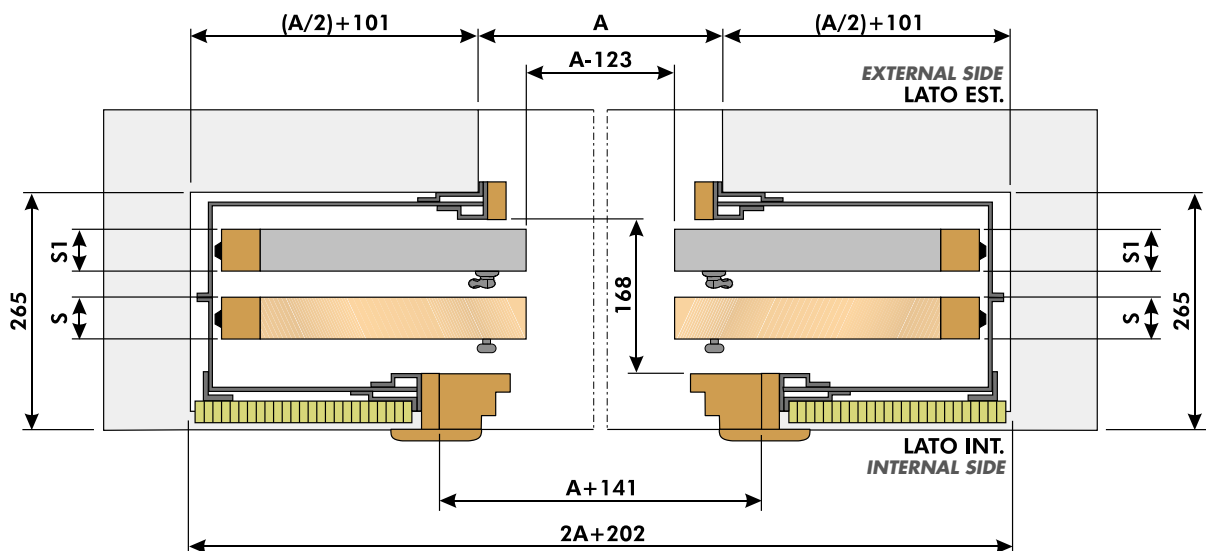
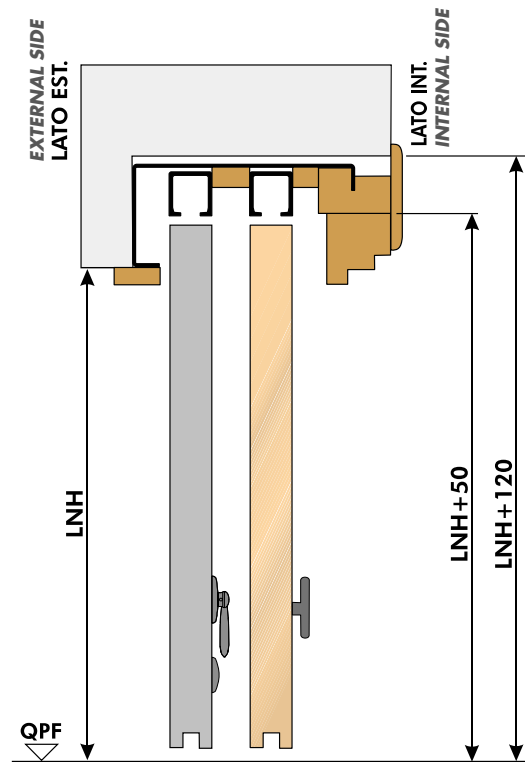
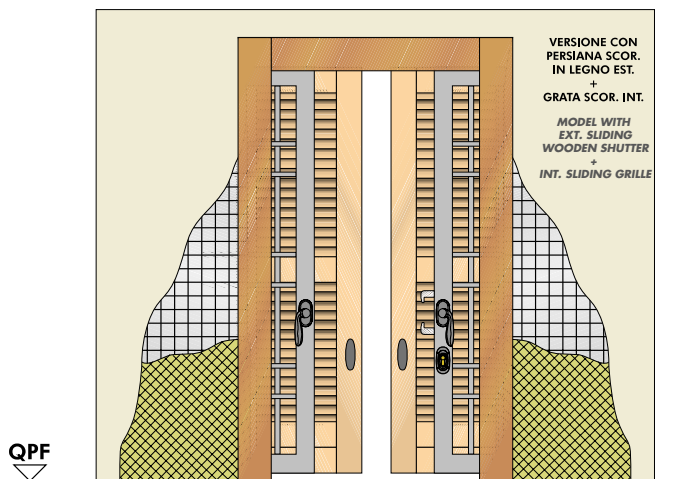
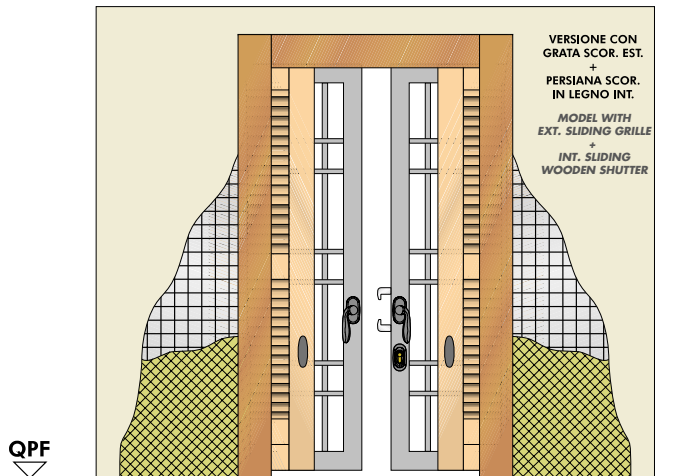

**MISURE DIMENSIONS**

A	LNH	GRATA GRILLE	PERSIANA SHUTTER
Da/From 725 a/to 5125	Da/From 800 a/to 2900	S1 = 45 H = LNH+12 L = (A/2)+27	S = 40/60 H = LNH+12 L = (A/2)+27

LE MISURE SONO ESPRESSE IN MILLIMETRI

A=LARGHEZZA VANO MURO  
 LNH= ALTEZZA VANO MURO

DIMENSIONS ARE EXPRESSED IN MM

A = WALL OPENING WIDTH  
 LNH = WALL OPENING HEIGHT

SPACE DUO SINGOLO CON GRATA O PERSIANA IL LEGNO SCORREVOLI  
 PIU' FINESTRA O PORTA FINESTRA AD ALZANTE SCORREVOLE  
 SPACE DUO SINGLE WITH GRILLE OR SLIDING WOODEN SHUTTER PLUS  
 WINDOW OR LIFT SLIDING FRENCH DOOR

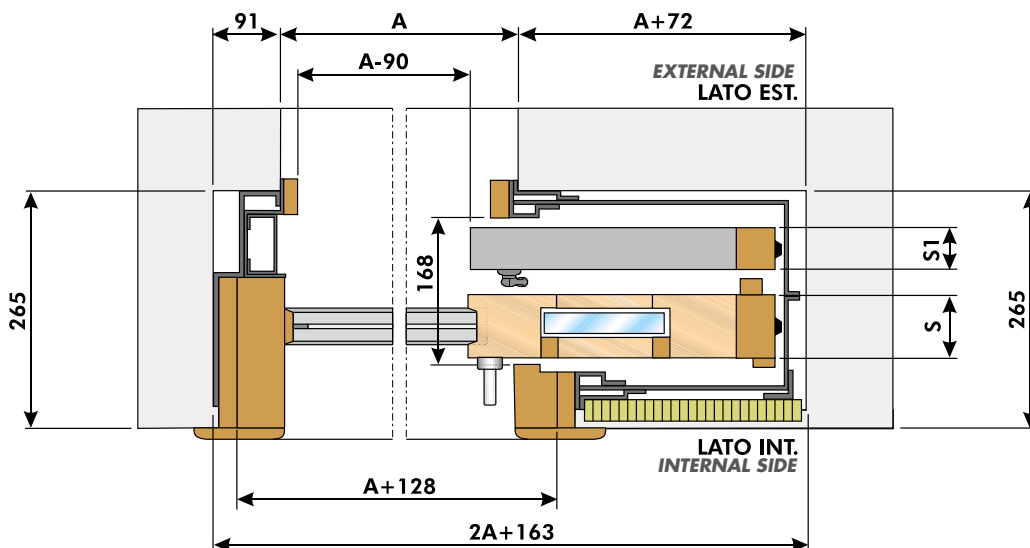
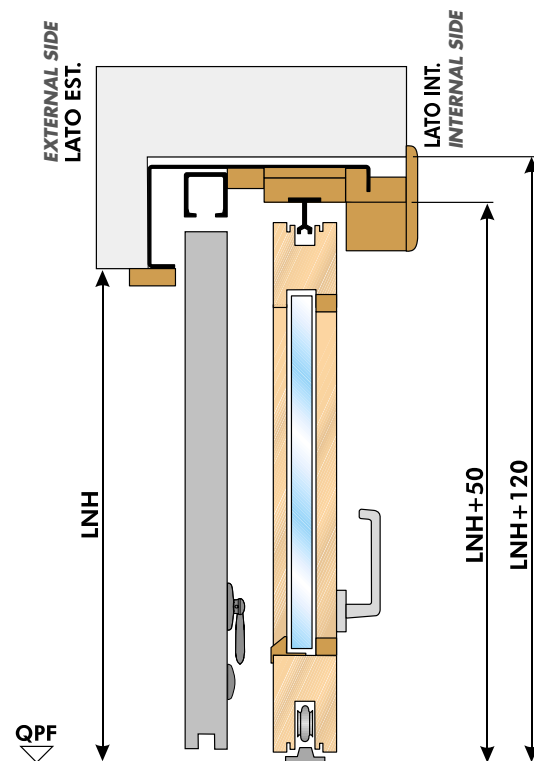
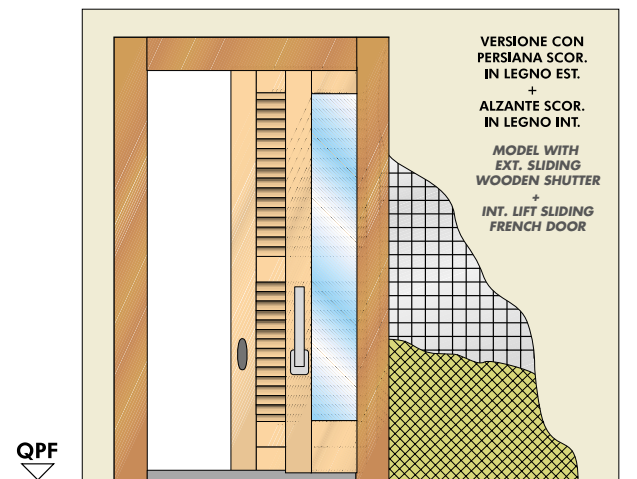
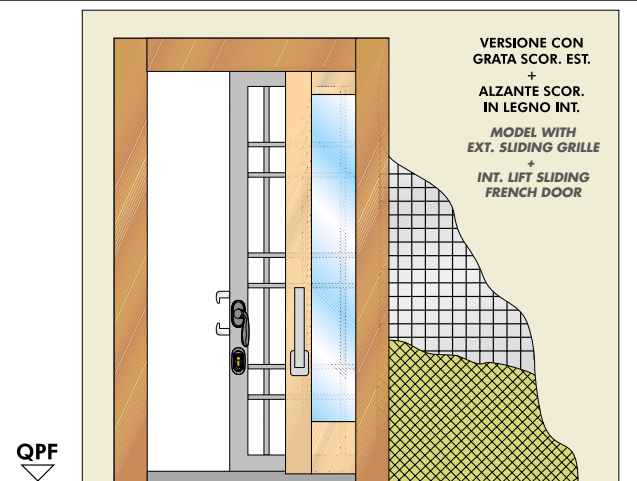

**MISURE DIMENSIONS**

A	LNH	ALZANTE LIFT SIDE	GRATA GRILLE	PERSIANA SHUTTER
Da/From 690 a/to 2590	Da/From 800 a/to 2900	S= 56/68 H= LNH+18 L= A-2	S1= 45 H= LNH+12 L= A+32	S1= 40/60 H= LNH+12 L= A+32

LE MISURE SONO ESPRESSE IN MILLIMETRI

A=LARGHEZZA VANO MURO  
 LNH= ALTEZZA VANO MURO

DIMENSIONS ARE EXPRESSED IN MM

A = WALL OPENING WIDTH  
 LNH = WALL OPENING HEIGHT



SPACE DUO DOPPIO CON GRATA OPERSIANA IL LEGNO SCORREVOLI  
 PIU' FINESTRA O PORTA FINESTRA AD ALZANTE SCORREVOLE  
 SPACE DUO DOUBLE WITH GRILLE OR SLIDING WOODEN SHUTTER PLUS  
 WINDOW OR LIFT SLIDING FRENCH DOOR

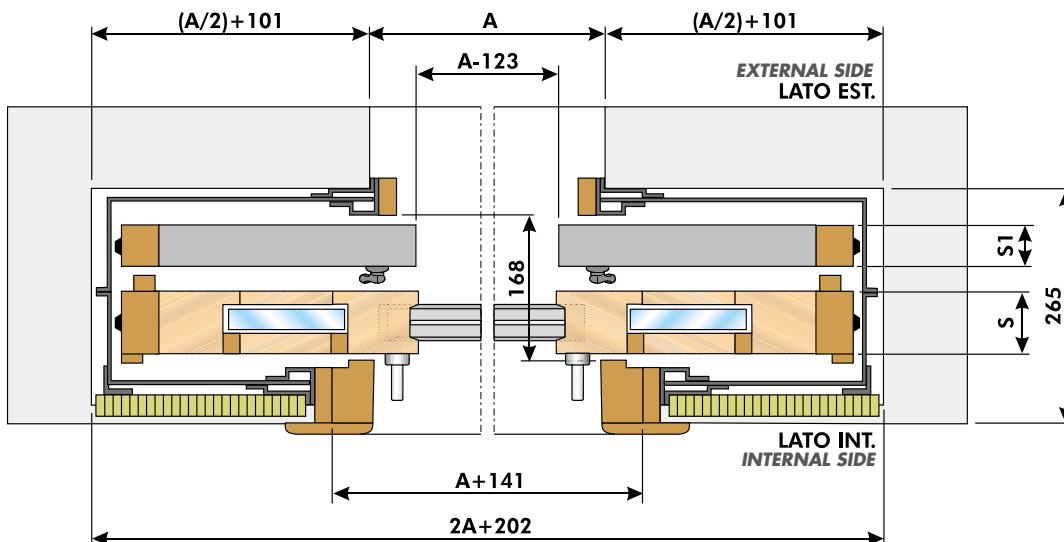
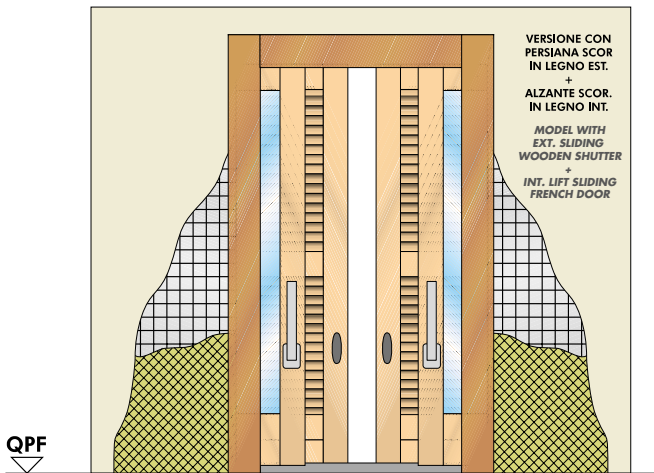
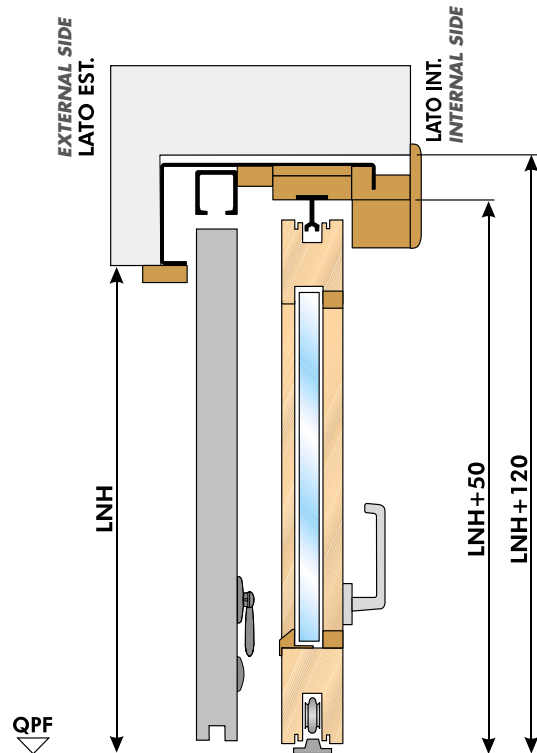
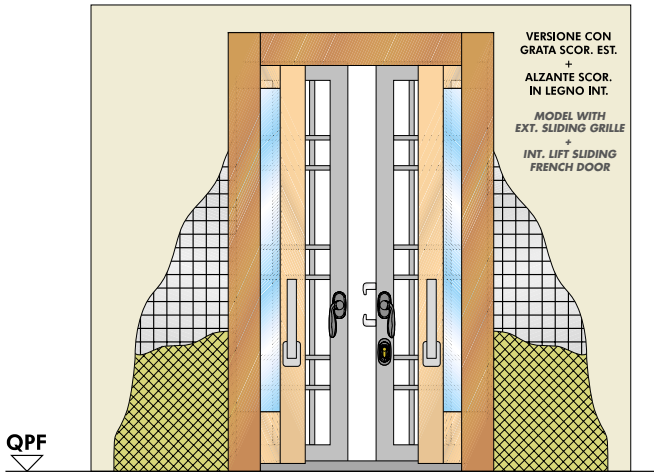

**MISURE DIMENSIONS**

A	LNH	ALZANTE LIFT SIDE	GRATA GRILLE	PERSIANA SHUTTER
Da/From 1325 a/to 5125	Da/From 800 a/to 2900	S= 56/68 H= LNH+18 L= (A/2)+27	S1= 45 H= LNH+12 L= (A/2)+27	S1= 40/60 H= LNH+12 L= (A/2)+27

LE MISURE SONO ESPRESSE IN MILLIMETRI

A=LARGHEZZA VANO MURO  
 LNH= ALTEZZA VANO MURO

DIMENSIONS ARE EXPRESSED IN MM

A = WALL OPENING WIDTH  
 LNH = WALL OPENING HEIGHT

SPACE DUO PRIMATO SINGOLO PER GRATE O PERSIANE IN LEGNO SCORREVOLI  
 SPACE DUO PRIMATO SINGLE FOR SLIDING GRILLES OR SLIDING WOODEN SHUTTERS

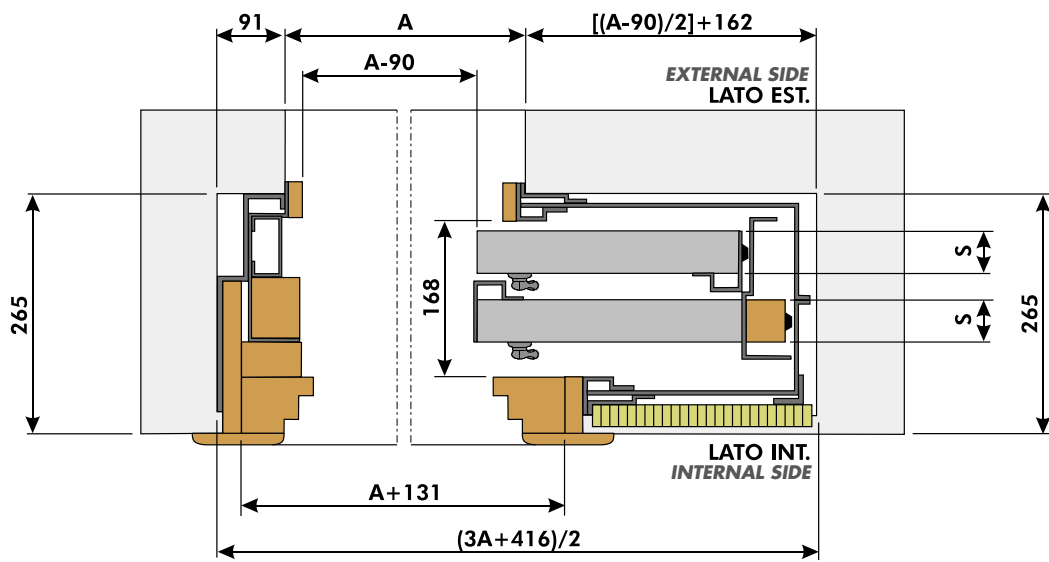
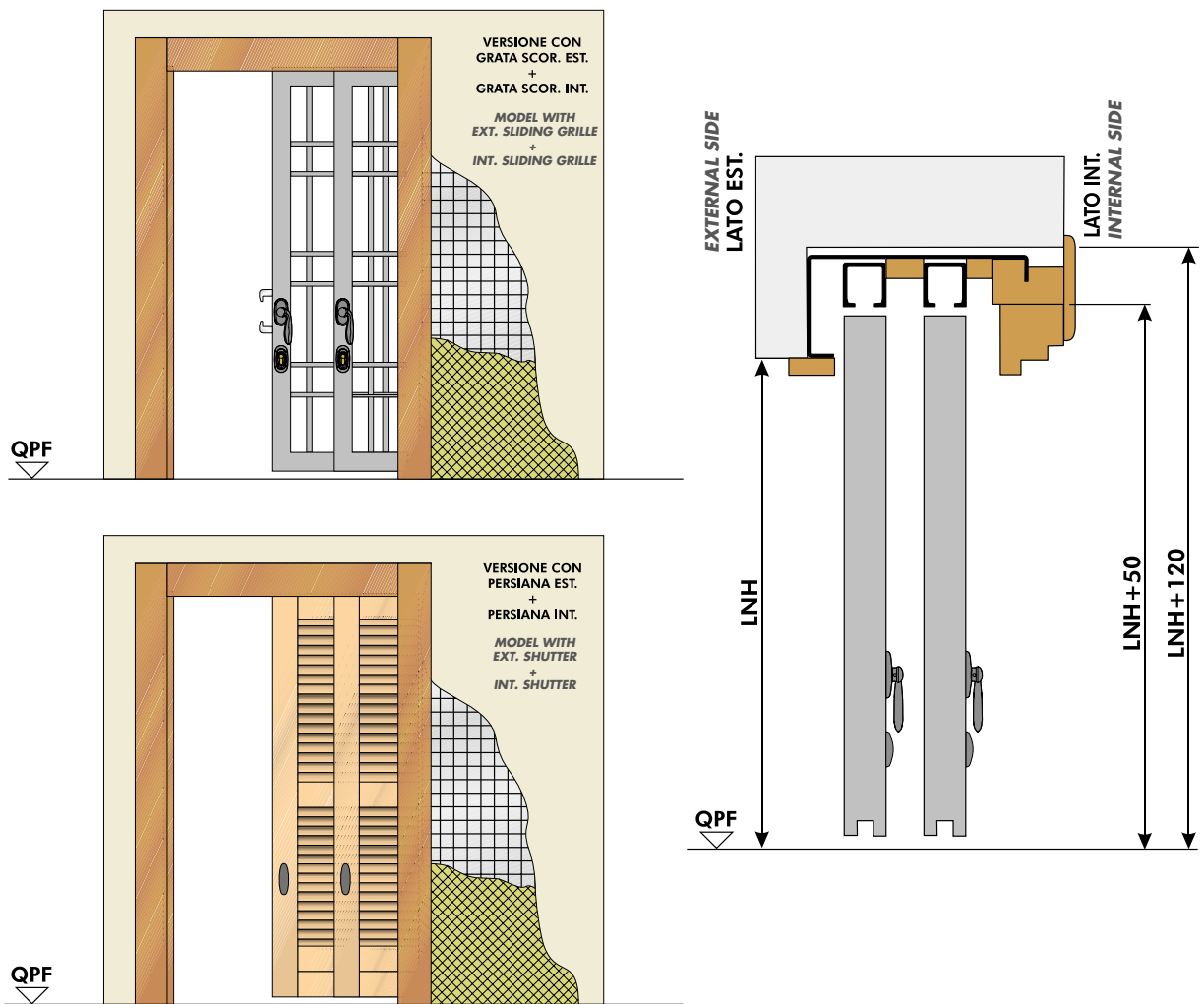

MISURE DIMENSIONS			
A	LNH	GRATA GRILLE	PERSIANA SHUTTER
Da/From 1290 a/to 5090	Da/From 800 a/to 2900	S = 45 H = LNH + 12 L = (A/2) + 61	S = 40/60 H = LNH + 12 L = (A/2) + 61

LE MISURE SONO ESPRESSE IN MILLIMETRI

A = LARGHEZZA VANO MURO  
 LNH = ALTEZZA VANO MURO

DIMENSIONS ARE EXPRESSED IN MM

A = WALL OPENING WIDTH  
 LNH = WALL OPENING HEIGHT







Space Trio per finestra scorrevole più grata scorrevole più oscurante scorrevole

*Space Trio for sliding window and sliding grille and sliding shutter*

SPACE TRIO SINGOLO PER GRATA PIU' PERSIANE IN LEGNO SCORREVOLE PIU' FINESTRA O PORTA FINESTRA AD ALZANTE SCORREVOLE  
 SPACE TRIO SINGOLO PER GRATA PIU' PERSIANE IN LEGNO SCORREVOLE PIU' FINESTRA O PORTA FINESTRA AD ALZANTE SCORREVOLE

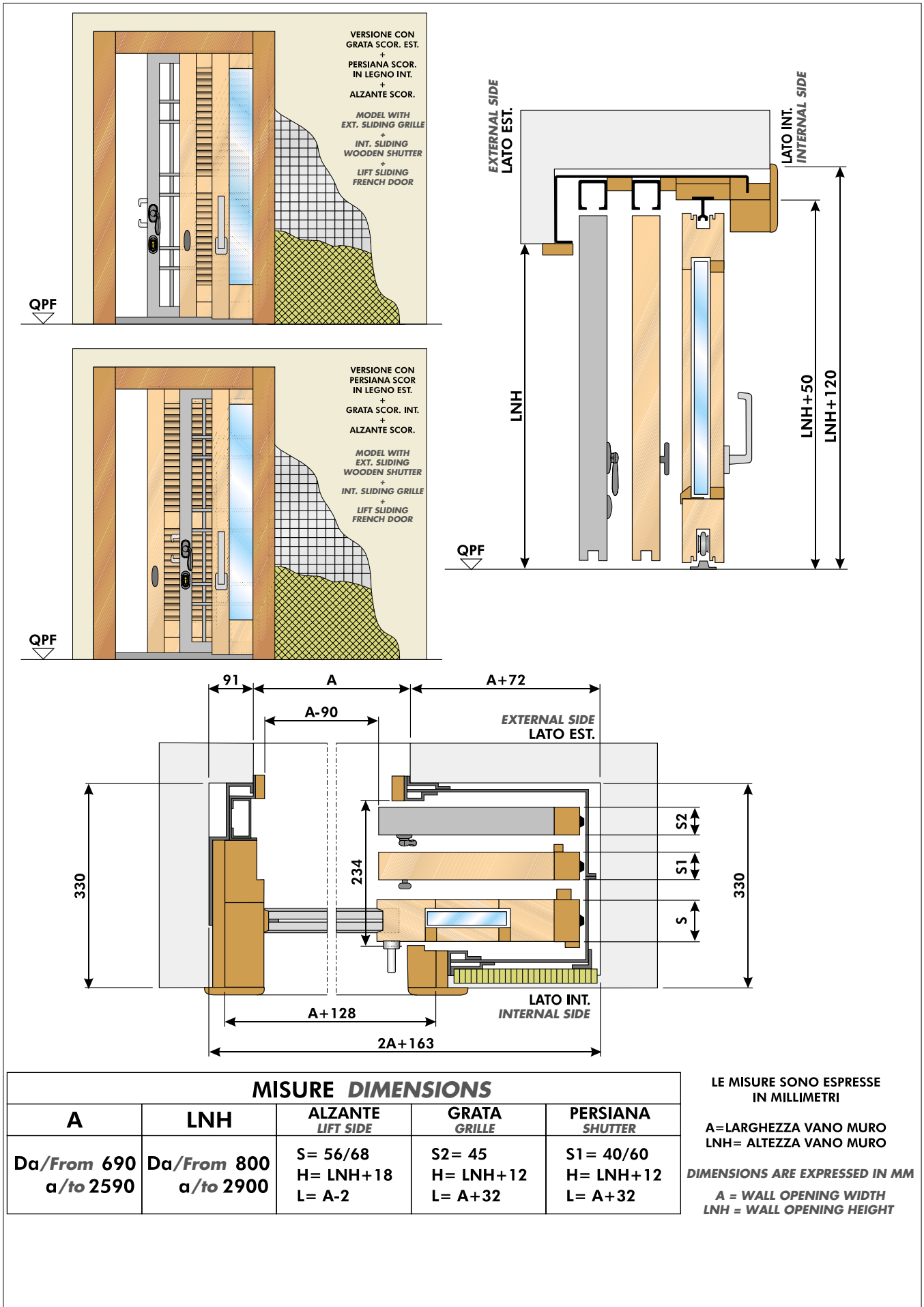

SPACE TRIO DOPPIO PER GRATA PIU' PERSIANE IN LEGNO SCORREVOLE PIU'  
 FINESTRA O PORTA FINESTRA AD ALZANTE SCORREVOLE  
 SPACE TRIO DOUBLE FOR GRILLE AND SLIDING WOODEN SHUTTER PLUS  
 WINDOW OR LIFT SLIDING FRENCH DOOR

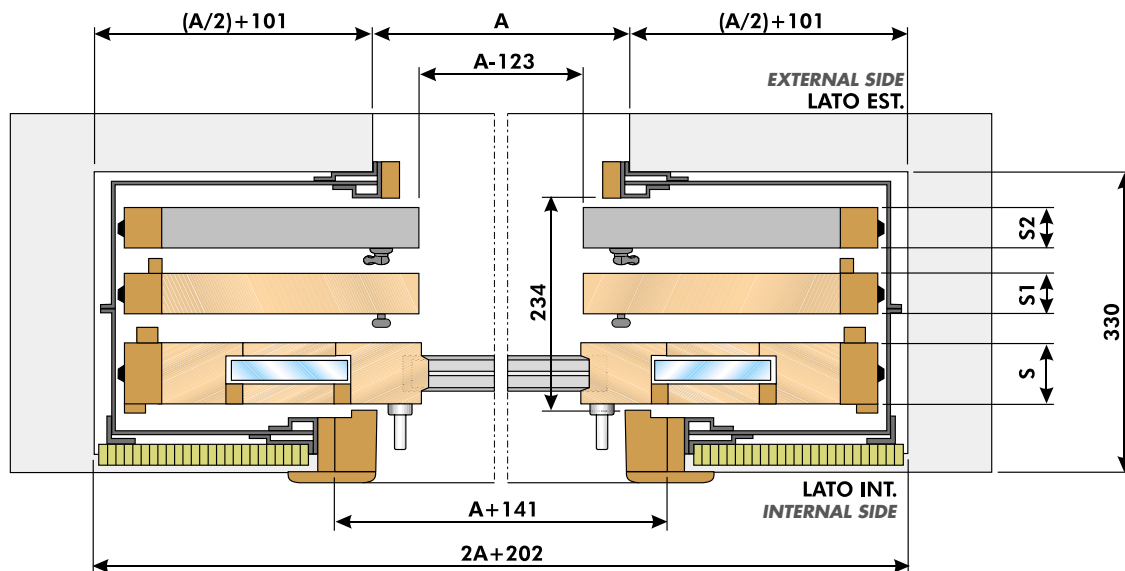
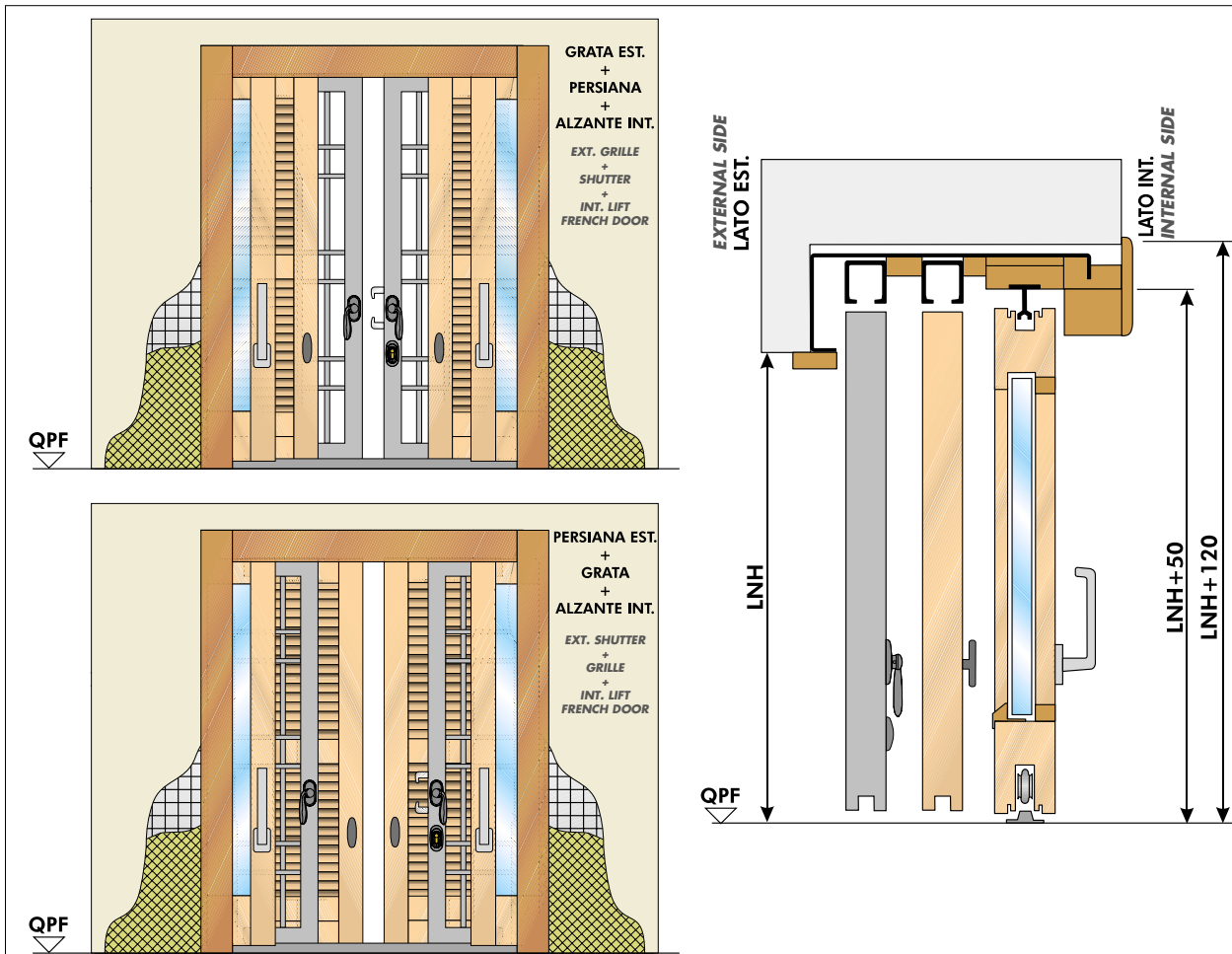

**MISURE DIMENSIONS**

A	LNH	ALZANTE LIFT SIDE	GRATA GRILLE	PERSIANA SHUTTER
Da/From 1325 a/to 5125	Da/From 800 a/to 2900	S= 56/68 H= LNH+18 L= (A/2)+27	S2= 45 H= LNH+12 L= (A/2)+27	S1= 40/60 H= LNH+12 L= (A/2)+27

LE MISURE SONO ESPRESSE  
 IN MILLIMETRI

A=LARGHEZZA VANO MURO  
 LNH= ALTEZZA VANO MURO

**DIMENSIONS ARE EXPRESSED IN MM**

A = WALL OPENING WIDTH  
 LNH = WALL OPENING HEIGHT

